

INNOVATIVE BATHING SOLUTIONS
DESIGNED FOR A LIFETIME



www.best-bath.com



WHY BEST BATH?



We offer a unique approach to your bathing remodel needs with commercial quality showers and walk-in tub systems designed specifically to meet your needs today and into the future.

All Best Bath products are manufactured in the USA. 

Each shower, walk-in tub and pan system is pre-leveled at the factory eliminating floor modifications and leveling headaches.

Innovative leak-proof joints create trouble-free installations and add value with reduced construction requirements.

Our composite wall system incorporates a plywood core on every unit. This solid wall system enables total freedom in placement of all accessories including seats and safety bars to individual needs.

We use authentic ceramic tile to create our production process. This way you get the look of tile without the cleaning hassles and sanitation issues of grout.

We offer the unique ability to add custom color to our tiles with accent colors. Also, safety bars, seats and other accessories can be custom colored to match your interior finishes.

It makes little sense to cover up problems. Our full line of showers and walk-in tubs are specifically engineered to professionally convert a standard bathing space into an accessible, attractive and safe bathing area.

Our system saves significant installation time and enables a quicker, more professional bathroom renovation. When your loved one needs accessible bathing, we want to solve that bathing issue quickly and also with a long-term solution.

As accessible bathing experts, we offer the training, knowledge and experience to create safe bathing solutions for people of all abilities. Also, we have the passion to treat every customer like a family member, because with us, you are.



LEAK PROOF, MULTI-PIECE SHOWERS FOR REMODELING



Best Bath Composite Floor

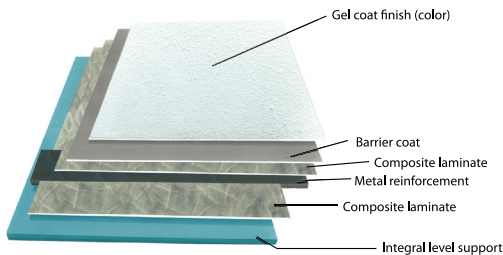

Best Bath Composite Wall

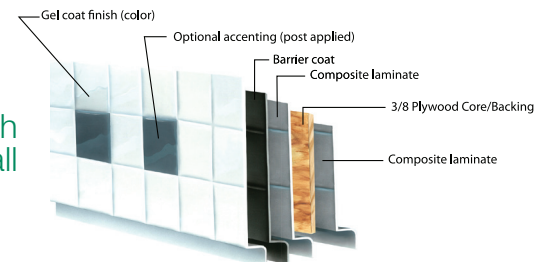

NEED IT NOW PROGRAM

How fast do you need it?

For those who need a complete shower package shipped right away, we now stock a selection of models that are just waiting for your order! **NEED IT NOW Packages** are processed within 24 hours of your order placement and promptly shipped. And the shipping is free. *(up to \$300)



These packages include **white only units**, stainless steel safety bars, shower seat, Symmons shower valve with handheld shower system, caulkless drain, curtain rod with mounting hardware, heavy vinyl shower curtain, and TWS where applicable.

For a complete list of available models go to the Best Bath website or contact your sales manager.



24hr
processing + *free shipping!**

Take it up to the next level!

This new program allows you more flexibility - select any shower or shower/tub combo and upgrade with an accessory package. You can choose to order a solid surface shower or add color accenting to your new shower/tub combo. When you are ready to order just ask to have it accessorized!

Everything you need for your bathroom remodel in one easy package with free shipping up to \$300.

Each package includes stainless steel safety bars, shower seat, Symmons shower valve with handheld shower system, caulk-less drain, curtain rod with mounting hardware, heavy vinyl shower curtain, and TWS where applicable.



BARRIER FREE & ACCESSIBLE MODELS

One way to make a bathroom safer and easier to navigate is to renovate with a barrier-free shower.

Barrier-free models are showers designed with low thresholds angled .5 to 2.25 inch that enable users of limited mobility to more easily step into the shower or move a wheelchair over the threshold with minimal effort.

All units are multi-piece for easy installation and have a full 3/8 inch plywood core in the walls enabling installation of safety bars and seats anywhere on the unit.

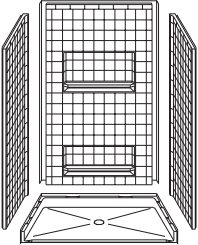
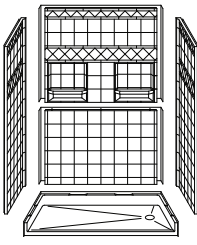
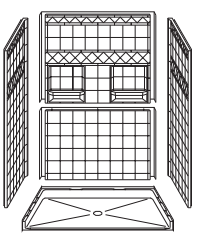
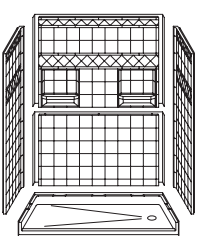
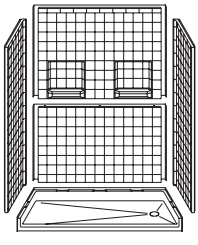
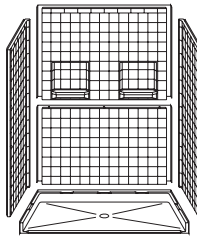
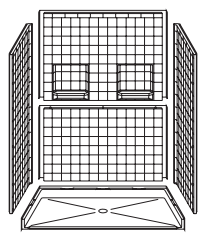
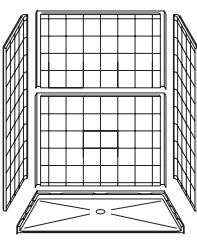
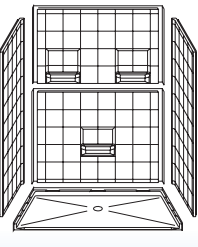
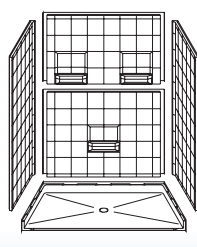
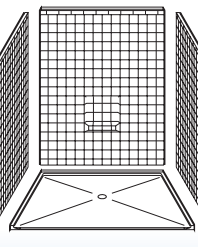
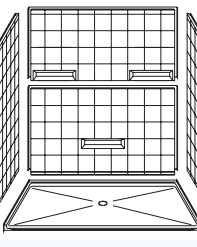

 4LRS4834B5B	 5LDS5430B17T	 5LDS5436B75B	 5LDS6030B17T
 5LRS6030B17T	 5LRS6032B75B	 5LRS6034B75B	 5LES6036FB75B
 5LES6036B75B	 5LES6042B1B	 4LRS6060B1B	 5LES7248B1B

Pans only are offered for all units. Many more models are available than what is shown.

For a complete list of available barrier-free showers and tubs visit our website at www.best-bath.com

REMODELER MODELS

LIMITED
30 Year Warranty
 All Showers - Tub Showers - Pans
 Best Bath
Made in America

Best Bath Systems remodeler showers and tubs set the standard for beauty, durability and ease of maintenance.

Ideal for home bathroom remodeling projects, our multi-piece models feature structurally reinforced walls, snap joint assembly and pre-leveled shower pans ensuring minimal bathroom downtime.

These units feature traditional threshold curbs in the 5 to 6 inch range.



For a complete list of available remodel showers and tubs visit our website at www.best-bath.com

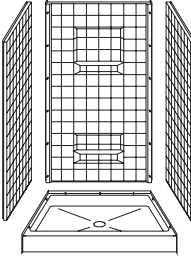
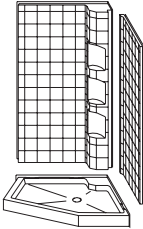
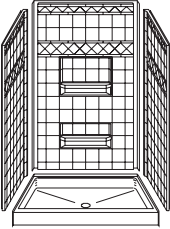
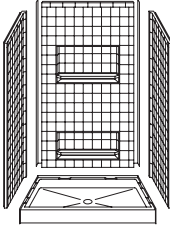
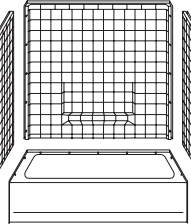
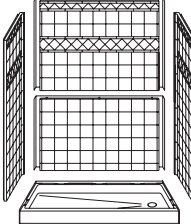
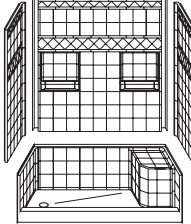
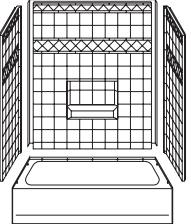
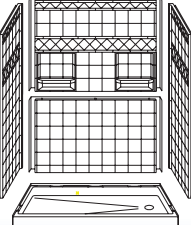
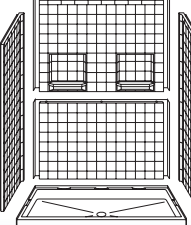
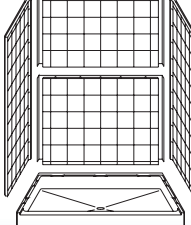
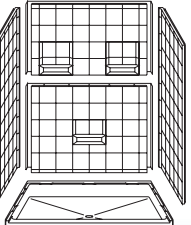

 4RS3636	 3LEN4242	 4LDS4834	 4LRS4834
 4RTS6029	 5LDS6030FB	 4LDSS6030	 4LDTS6032
 5LDS6033	 5LRS6034	 5LES6042FB	 5LES6042

Pans only are offered for all units. Many more models are available than what is shown.

CLASSIC WALK-IN TUB SERIES

The purchase of a luxury walk-in or transfer tub is a once in a lifetime experience. The selection should be made with the utmost care and discrimination!



Escape

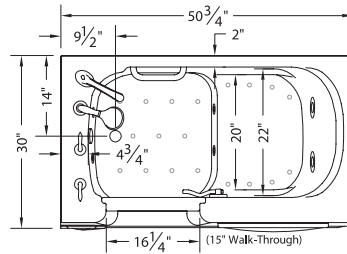

Liberty

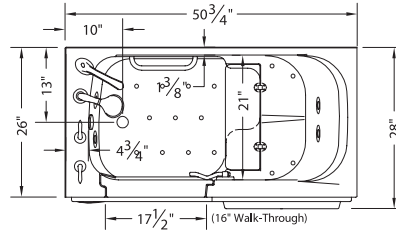

Escape Plus

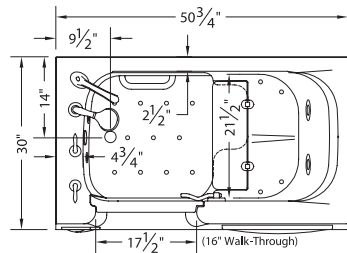

Big E

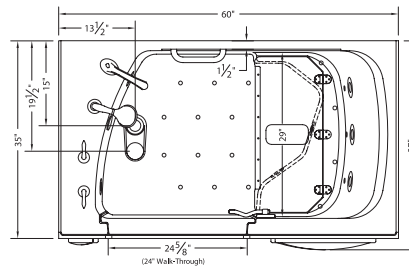

Standard Walk-in Tub Features:

Step into the ultimate bathing experience with a Best Bath walk-in tub. Twice the depth of normal tubs, each unit has a comfortable contoured seat back, safety grab bar and heated seat with controls - all standard features. Our walk-in tubs are designed to fit seamlessly into your current bathroom and allow you the options to choose custom colors and accenting.

- Durable and ergonomic patented door latch, all stainless steel and brass components, no plastic. Should any adjustment ever be required it is easily done at the lever
- NEW FEATURE - Heated seat with timed controls
- Stainless steel cable operated tub drain mechanism with a lever handle for easy operation
- Pre-installed plumbing with all connection lines for professional installation
- Flip-up seat. This unique feature allows for an easier entrance (except Escape model)

UPGRADES INCLUDE

- Jetted models feature the new Syllent Pump: the quietest whirlpool pump available. This is the only pump available with a heat recycling feature to help maintain water temperature and avoid the need for an in-line heater. This pump has no seals to leak, no bearings to wear out and has a 10 year manufacturer's warranty
- Matching wall surround available
- Optional ozone sanitation system available



ADL Tub Features:

Best Bath's ADL Spa is truly universal, providing a safe, accessible, full-sized slide-in bath designed for everyone. Developed with the collaboration of two universities and several health organizations, this tub provides an elevated bathing access that supports a safe, independent bathing experience at home or helps minimize the strain for caregivers.

- Bathtub with unique sliding door and automatic safety latch
- White-finished cabinet fronts and drawers, with all hardware
- Right or left opening door choice
- Secondary drain in door track
- Access for easy connection to existing drain
- Contoured padded neck pillow in a variety of colors
- Four built-in grab bars for safety and easy movement
- Ergonomic deck-mount chrome drain control (drain handle not drilled, for flexible installation)

UPGRADES INCLUDE

- 7-jet whirlpool system with massaging back, leg and foot jets
- Hygienic 20-jet air massage system with 3-speed heated jets
- Color and finish options for tub and cabinets
- Automatic ozone disinfection system (no chemical additives)
- Seatbelt and Harness system
- Ergonomic door-handle extension
- Safety Plus System features hi-flow thermostatic, anti-scald control valves
- Electronic touch pad control panel with digital temperature display



(Cabinet finish is an upgrade)

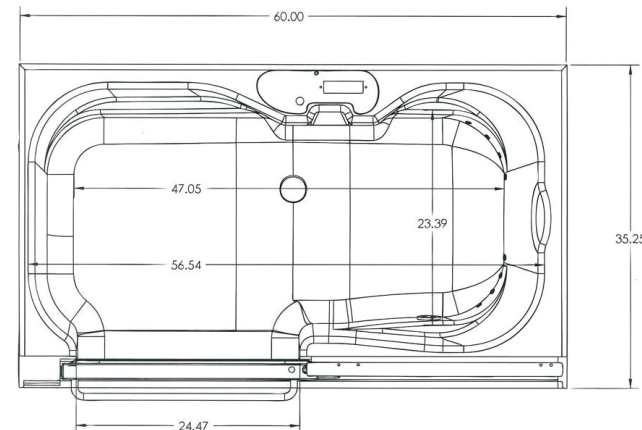

ACCESSORIES

Waterstopper - Collapsible Water Retainer

Made of heavy gauge EPDM rubber to create a "T" shaped curb that stands up to water yet compresses under foot or wheel. WaterStoppers are available in either grey or beige and are cut to fit on site and installed with peel and stick adhesive and provided end caps.



UP TO 36 IN. KTWS(B/G)3(S/L/U)
 UP TO 48 IN. KTWS(B/G)4(S/L/U)
 UP TO 60 IN. KTWS(B/G)5(S/L/U)
 UP TO 72 IN. KTWS(B/G)6(S/L/U)
 UP TO 120 IN. KTWS(B/G)10(S/L/U)

KTWSB3S
 K TWS
 KIT T-WATER STOPPER

COLOR
 B FOR BEIGE
 G FOR GREY

LENGTH
 3 (36 IN)
 4 (48 IN)
 5 (60 IN)
 6 (72 IN)
 10 (120 IN)

END CAPS
 S - SMALL
 L - LARGE
 U - BOTH

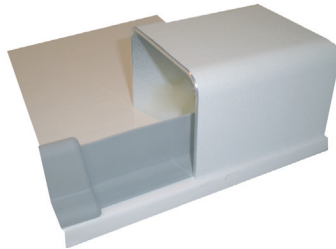

Semi-Permanent Threshold

These are custom made to fit each unit. They are constructed of heavy gauge aluminum and powder coated to match the unit. They are built to snugly fit the unit and be siliconed in place. They are strong enough to hold a traditional glass shower door.

When necessary, the shower door and the semi-permanent threshold can be easily removed, leaving an accessible low threshold shower with a water retainer in place. The addition of a heavy duty weighted shower curtain completes the water retention system.

As conditions change you can replace the threshold over the WaterStopper, reinstall the shower door and you again have a traditional shower.

Safety Bars

We offer a full line of 1.25 and 1.50 inch diameter stainless steel safety bars.

Safety bar stocked sizes

LENGTH	MODEL #
12 INCH	GB12QSS
18 INCH	GB18QSS
24 INCH	GB24QSS
36 INCH	GB36QSS
48 INCH	GB48QSS



Color Safety Bars

In addition to stainless steel, you can color safety bars with our powder-coat service.

Stock Powder-coated Bars - White

Powder-coating safety bars to match accenting is also available. The safety bars should be powder-coated first and then match the paint for the accenting. This process generally takes about two weeks.

Custom colors require color samples and increase the cost and lead times, contact your Sales Rep for details.



We also offer a wrinkle coat finish for additional gripping texture. Available only in white and almond.

Other metal finishes such as brass, oil rubbed bronze or brushed nickel can be special ordered.

Padded Seat with swing down legs

We offer a 22" x 16" padded seat of steel construction with adjustable feet. This unit securely screws into the wall and folds up and out of the way for extra space.

Seats can be powder coated different colors to match safety bars. (non-padded seats available, call for details)



22 X 16 SEAT | WHITE PADDED
MODEL # | SE2216PDSWH

Waffle Ramp Material

Light weight modular ramp material that is easy to install, move and clean. Available in gray color only.

Material custom ordered, call for details



Mixing Valves and Hand Shower on glide bar

We offer our most popular handheld shower and valve as a package.



Mixing Valve Package

Kit includes: Mixing valve and trim, glide bar, handheld shower head, hose, supply elbow and vacuum breaker

PACKAGE MODEL # | ACXSYM1001

When ordering Individual Items use:

Item	Model #
MIXING VALVE AND TRIM	ACXSYM1019
GLIDE BAR	ACXGLIDEBAR
HANDHELD SHOWER HEAD	ACXHANDHELD
HOSE	ACXCSI1000
SUPPLY ELBOW	ACXCSI1001
VACUUM BREAKER	ACXCSI1002

ITALIAN GLIDE BAR **ACXISA1000**



This optional handheld shower with glide bar has an easy one-hand button adjustment to adjust the shower position. Ideal for those with limited mobility.

Best Bath Systems, Inc.

723 Garber Street
Caldwell, ID 83605

Toll free: (800) 727-9907

Toll free fax: (866) 333-8657

www.[best-bath.com](http://www.best-bath.com)

